

Het fabrieksschema, dat u zoekt, staat op de volgende pagina.



Groothandel Nelec heeft voor alle tweedraads deurcommunicatie van BTicino zeer duidelijke Nederlandse schema's en gebruiksaanwijzingen gemaakt. U vindt alles op www.nelec.com.



Als u BTicino deurcommunicatie koopt bij Nelec, krijgt u voor ieder project een aansluitschema op maat, worden de buitenposten in elkaar gezet en zijn alle videofoons voorgeprogrammeerd. De monteur kan direct aan de slag en als hij een vraag heeft, krijgt hij bij Nelec iemand met verstand van zaken aan de lijn.



Klik op deze pagina om automatisch naar www.nelec.com te gaan.

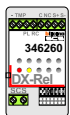
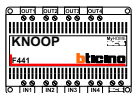
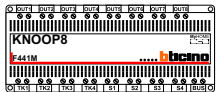
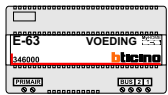
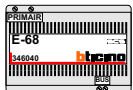

nelec
 INTERCOM MADE EASY



The Bticino factory schema or manual you're looking for is on the next page.

Specialized wholesaler Nelec has made excellent manuals in Dutch for all BTicino two-wire intercom components. Visit dedicated website www.nelec.com by clicking this page.

wholesaler Nelec BV
 intercom made easy
www.nelec.com
 Gyroscopweg 106
 1042 AX Amsterdam
 Postbus 20674
 1001 NR Amsterdam

e-mail info@nelec.com

Telefoon 020-6 352 350
 Verkoop 020-6 352 351
 Administratie 020-6 352 352
 Techniek 020-6 352 353
 Offertes 020-6 352 357

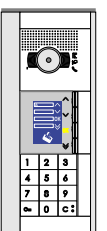
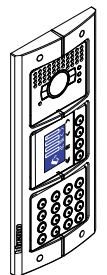
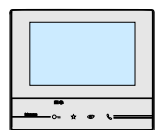
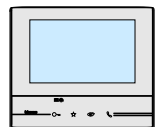
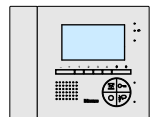
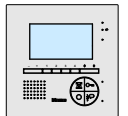



SWING

Black and white base video handset

344832

Description

Wall video handset with black and white 4" monitor for use in 2 WIRE systems. With the following pushbuttons for video door entry system functions: door lock release, entrance panel/ camera scrolling activation, staircase lights switching on and intercom. The volume of the bell can be adjusted, or the bell may be disabled. With 16 different types of already preset bells, selectable for the call to the floor, main entrance panel bell, and intercom functions. It also has a secret conversation function, and "door status" control (function possible in conjunction with the door lock actuators 346230 - 346260 and with CISA ELETTRIKA door lock with 346240 accessory). Wall mounting bracket supplied as standard.

Correlated items

- 346020 (additional 2 DIN modules power supply) - optional, for local powering of the video handset, when maximum installation distances are necessary
- 346230 2 DIN door lock actuator
- 346260 4 DIN timed door lock actuator
- 346240 CISA ELETTRIKA door lock accessory

Technical data

Power supply from SCS BUS :	20.5 – 27 Vdc
Stand-by absorption:	5 mA
Max. operating absorption:	400 mA @ 27 V - 650 mA @ 20.5 V
Operating temperature:	5 - 40°C

Dimensional data

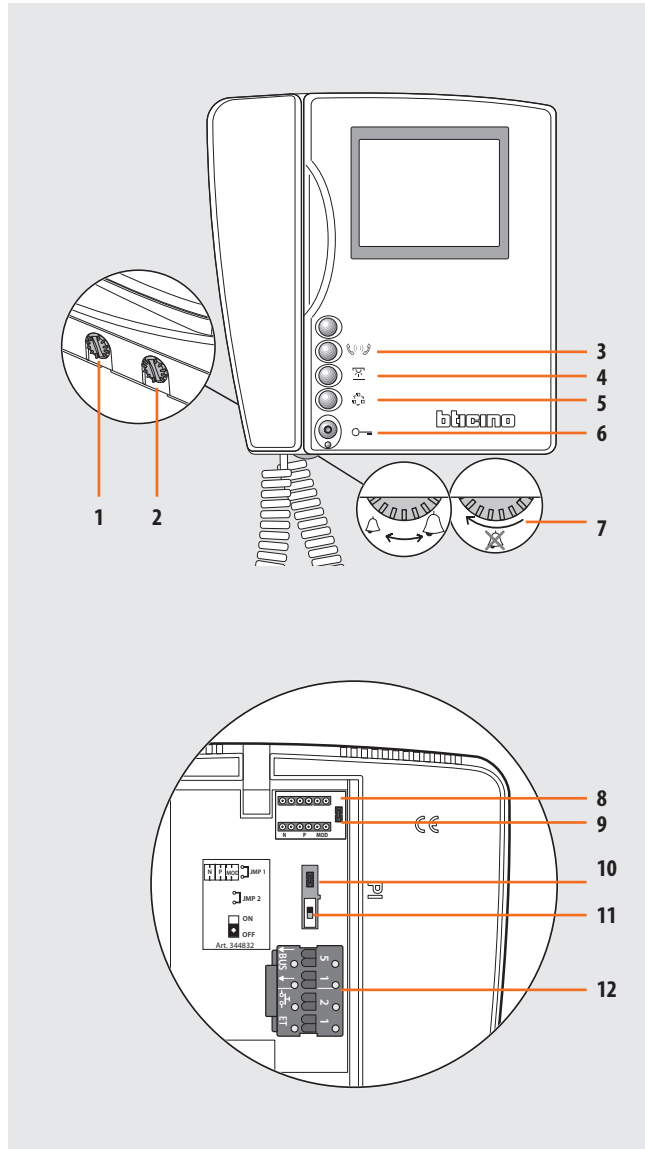
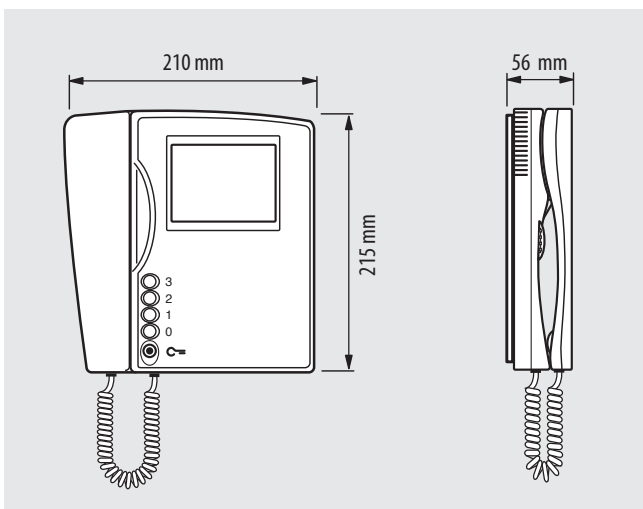

Legend

1. Monitor contrast adjustment
2. Monitor brightness adjustment
3. Intercom call pushbutton
4. Staircase lights pushbutton
5. Entrance panel/camera scrolling activation pushbutton
6. Door lock release pushbutton + door status LED
7. Bell adjustment and exclusion
8. Configurator socket
9. MASTER/SLAVE jumper (Remove to enable SLAVE)
10. Additional power supply jumper. (Remove if a local power supply is connected to clamps 1 - 2)
11. Line termination ON/OFF microswitch
12. Connection clamp for: 2 WIRE BUS, call to the floor, additional power supply and additional bell.

Configuration

⊙	⊙	⊙	⊙	⊙	⊙
N		P		MOD	
⊙	⊙	⊙	⊙	⊙	⊙

The video handset must be physically configured in terms of:

N - handset number

The N configurator assigns to each video handset an identification number within the 2 wire system. The handsets must be configured in progressive order. Handsets with parallel connection (max 3 are allowed inside apartments without 346850 interface) must be configured using the same N configurator.

P - entrance panel number

The P configurator identifies the entrance panel associated, or the first entrance panel to activate before pressing the key $\overset{\square}{\underset{\square}{\text{A}}}$ and which door lock is activated when the key $\text{O}=\text{}$ is pressed while the video handset is idle.

Configuration in P	Key function $\overset{\square}{\underset{\square}{\text{A}}}$
P= 0-96	Activation of the audio function on the entrance panel (configured with P= 0-96)

Configuration in P	Key function $\text{O}=\text{}$
P= 0-96	Opening of the EP door lock (configured with P= 0-96)

M - intercom operating mode

The intercom function enables audio communication (maximum 3 minutes) between handsets within the same apartment. Two configuration modes are possible:

M = 00 (no configurator connected). Multi-family Intercom between devices (max. 3) configured with the same N configurator.

M = 10 general intercom to be used in single family systems, or in systems installed below the apartment interface 346850.

Installation

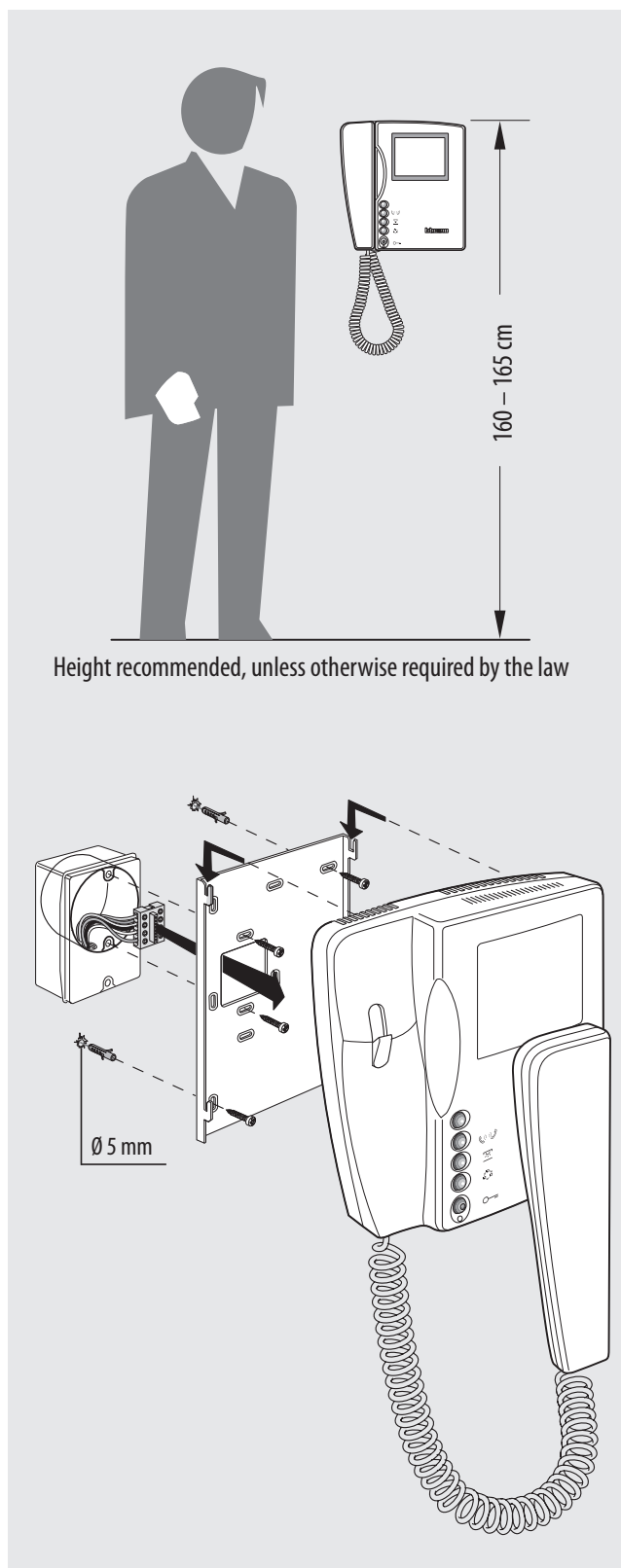

Height recommended, unless otherwise required by the law

General rules for installation

The connection of the devices is non polarised, and may be completed by wiring the system in two different ways:

- **In-out** wiring directly on the device clamps (handsets)
- **star** wiring, with floor shunt (item 346841) installed directly inside the round box (**recommended**).

The use of conductors with characteristics other than the prescribed ones does not guarantee good performance and good quality of the video signal. Therefore, only the cables described in the following tables should be used.

When using the distance tables, interfaces 346850 and 346581 must be treated as handsets within LINE C, and as a two buttons entrance panels within line B.

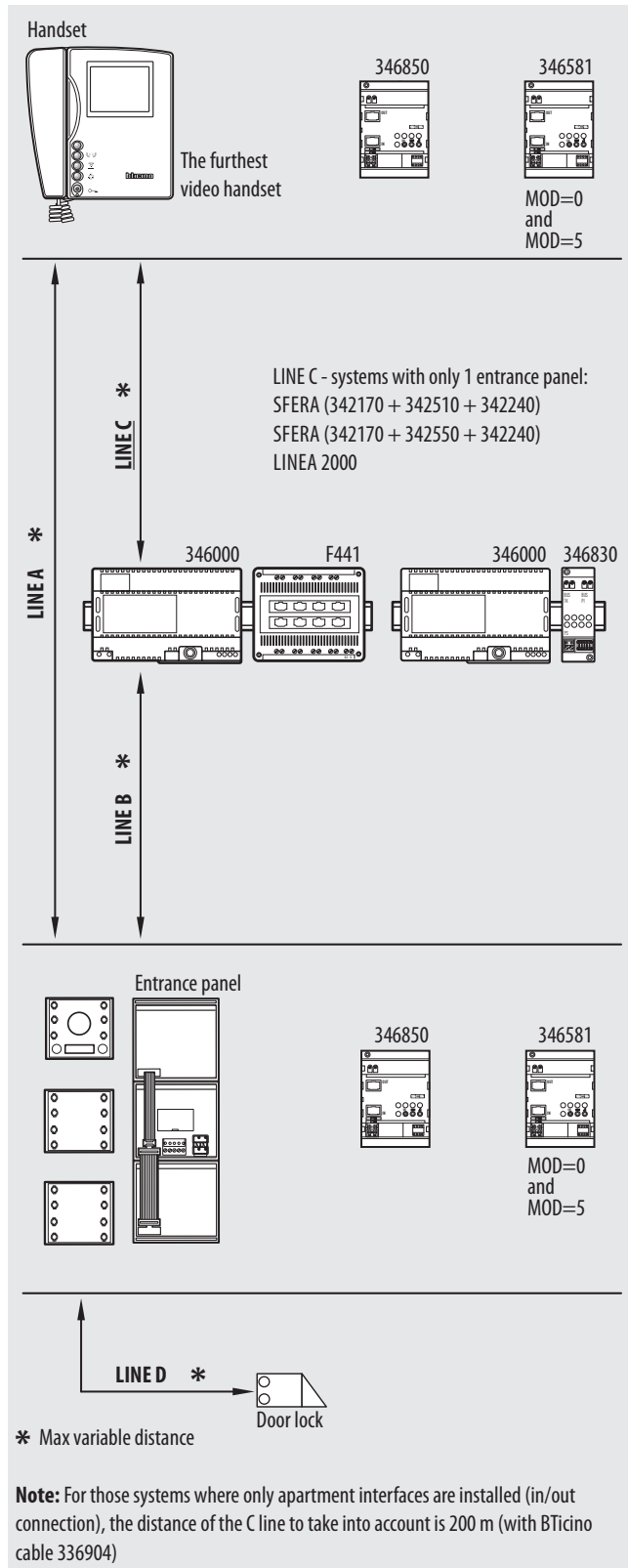

Max. distances and features of cables in MULTI-FAMILY VIDEO SYSTEMS

The **HANDSETS** classed as (**BASE**) are: BASE SWING video handset;

The **HANDSETS** classed as (**TRADITIONAL**) are: PIVOT, SWING, SPRINT, POLYX VIDEO;

The **HANDSETS** classed as (**ADVANCED**) are: POLYX VIDEO DISPLAY, AXOLUTE VIDEO DISPLAY, AXOLUTE VIDEO STATION, AXOLUTE N&W VIDEO STATION, POLYX MEMORY STATION.

System created using traditional handsets and at least one base swing handset - black and white entrance panel

Maximum LINE A distance, Entrance panel - furthest Handset

Cable section mm ²	2 normal cables >0.2 mm ²	BTicino 336904 cable	Telephone twisted pair - 0.28 mm	A pair of the multi-pair data cable C9881U/5E
2 HA/2 pushbuttons	50	200	135	135
5 HA/5 pushbuttons	50	200	135	120
10 HA/10 pushbuttons	50	200	135	115
26 HA/26 pushbuttons	50	200	135	105
40 HA/entrance panel with local power supply	50	200	135	-
40 HA/digital call modules	50	200	135	-

Maximum LINE C distance, Power supply - furthest Handset (1)

Cable section mm ²	2 normal cables >0.2 mm ²	BTicino 336904 cable	Telephone twisted pair - 0.28 mm ²	A pair of the multi-pair data cable C9881U/5E
2 In/out HA	45	100	65	45
5 In/out HA	45	100	65	45
10 In/out HA	45	100	65	45
18 In/out HA	45	100	65	45
22 In/out HA	40	95	65	40
26 In/out HA	40	90	60	40
5 HA (shunted)	45	100	65	45
10 HA (shunted)	40	95	65	40
18 HA (shunted)	40	85	55	40
22 HA (shunted)	-	75	50	-
26 HA (shunted)	-	60	40	-
30 HA (shunted) (2)	-	80	50	-
40 HA (shunted) (2)	-	60	40	-

Maximum LINE B distance, Entrance panel - Power supply

Cable section mm ²	2 normal cables >0.2 mm ² or L4669	BTicino 336904 cable	Telephone twisted pair - 0.28 mm ²	A pair of the multi-pair data cable C9881U/5E
2 pushbuttons	50	200	115	90
10 pushbuttons	50	170	100	75
26 pushbuttons	50	150	95	65
Digital call	50	150	95	65
Entrance panel with local power supply	50	200	140	120

Maximum LINE D distance Entrance panel - Door lock

Cable section mm ²	0.28 mm ²	BTicino L4669 cable	BTicino 336904 cable	1 mm ²
S+S- clamps	30 m	30 m	50 m	100 m

Note (1): LINE C valid for SFERA (342170 + 342510 + 342240), SFERA (342170 + 342550 + 342240), SFERA A/V (342560 + 342240) or LINEA 2000 entrance panels.

Note (2): if necessary, power the entrance panel locally.

WARNING: in order to reach longer distances, instead of the video adapter item. 346830, the audio/video node, item F441 (generating up to 4 risers), may be used. In this mode one of the previous conditions, with less Handsets and a longer distance on the C LINE, is recreated.

System created using advanced or traditional handsets and at least one base SWING handset – colour entrance panel
Maximum LINE A distance, Entrance panel - furthest Handset

Cable section mm ²	2 normal cables >0.2 mm ²	BTicino 336904 cable	Telephone twisted pair - 0.28 mm ²	A pair of the multi-pair data cable C9881U/5E
2 HA/2 pushbuttons	50	200	140	135
5 HA/5 pushbuttons	50	200	140	120
10 HA/10 pushbuttons	50	200	140	115
24 HA/24 pushbuttons	50	200	140	100
30 HA/entrance panel with local power supply	50	200	140	-

Maximum LINE B distance, Entrance panel - Power supply

Cable section mm ²	2 normal cables >0.2 mm ² or L4669	BTicino 336904 cable	Telephone twisted pair - 0.28 mm ²	A pair of the multi-pair data cable C9881U/5E
2 pushbuttons	50	200	115	90
10 pushbuttons	50	170	100	75
26 pushbuttons	50	150	95	65
Digital call	50	150	95	65
Entrance panel with local power supply	50	200	140	120

Maximum LINE C distance, Power supply - furthest Handset (1)

Cable section mm ²	2 normal cables >0.2 mm ²	BTicino 336904 cable	Telephone twisted pair - 0.28 mm ²	A pair of the multi-pair data cable C9881U/5E
2 In/out HA	45	100	65	45
5 In/out HA	45	100	65	45
10 In/out HA	40	90	60	40
18 In/out HA	40	85	55	40
24 In/out HA	-	75	50	35
5 HA (shunted)	40	100	65	45
10 HA (shunted)	40	85	55	40
18 HA (shunted)	-	80	50	-
24 HA (shunted)	-	50	-	-
30 HA (shunted) (2)	-	60	40	-

Maximum LINE D distance Entrance panel - Door lock

Cable section mm ²	0.28 mm ²	BTicino L4669 cable	BTicino 336904 cable	1 mm ²
S+S- clamps	30 m	30 m	50 m	100 m

Note (1): LINE C valid for SFERA (342170 + 342510 + 342240), SFERA (342170 + 342550 + 342240), SFERA A/V (342560 + 342240) or LINEA 2000 entrance panels.

Note (2): if necessary, power the entrance panel locally.

WARNING: in order to reach longer distances, instead of the video adapter item 346830, the audio/video node, item F441 (generating up to 4 risers), may be used. In this mode one of the previous conditions, with less Handsets and a longer distance on the C LINE, is recreated.

Max. distances and features of cables in SINGLE-FAMILY VIDEO SYSTEMS

The **HANDSETS** classed as (**BASE**) are: BASE SWING video handset;

The **HANDSETS** classed as (**TRADITIONAL**) are: PIVOT, SWING, SPRINT, POLYX VIDEO;

The **HANDSETS** classed as (**ADVANCED**) are: POLYX VIDEO DISPLAY, AXOLUTE VIDEO DISPLAY, AXOLUTE VIDEO STATION, AXOLUTE N&W VIDEO STATION, POLYX MEMORY STATION.

System created using traditional handsets and at least one base swing handset - black and white entrance panel

Maximum LINE A distance, Entrance panel - furthest Handset

Cable section mm ²	2 normal cables >0.2 mm ²	BTicino 336904 cable	Telephone twisted pair - 0.28 mm ²	A pair of the multi-pair data cable C9881U/5E
5 S-family HA/pushbutton EP	50	200	140	135
5 S-family HA/EP with local power supply	50	200	140	165

Maximum LINE C distance, Power supply - furthest Handset (1)

Cable section mm ²	2 normal cables >0.2 mm ²	BTicino 336904 cable	Telephone twisted pair - 0.28 mm ²	A pair of the multi-pair data cable C9881U/5E
5 In/out HA	45	100	65	45
5 HA (shunted)	45	100	65	45

Maximum LINE B distance, Entrance panel - Power supply

Cable section mm ²	2 normal cables >0.2 mm ²	BTicino 336904 cable	Telephone twisted pair - 0.28 mm ²	A pair of the multi-pair data cable C9881U/5E
2 pushbuttons	50	200	115	90
Entrance panel with local power supply	50	200	140	120

Note (1): LINE C valid for SFERA (342170 + 342510 + 342240), SFERA (342170 + 342550 + 342240), SFERA A/V (342560 + 342240) or LINEA 2000 entrance panels.

System created using advanced or traditional handsets and at least one base swing handset - colour entrance panel

Maximum LINE A distance, Entrance panel - furthest Handset

Cable section mm ²	2 normal cables >0.2 mm ²	BTicino 336904 cable	Telephone twisted pair - 0.28 mm ²	A pair of the multi-pair data cable C9881U/5E
5 S-family HA/pushbutton EP	50	200	140	135
5 S-family HA/EP with local power supply	50	200	140	165

Maximum LINE C distance, Power supply - furthest Handset (1)

Cable section mm ²	2 normal cables >0.2 mm ²	BTicino 336904 cable	Telephone twisted pair - 0.28 mm ²	A pair of the multi-pair data cable C9881U/5E
5 In/out HA	45	100	65	45
5 HA (shunted)	45	100	65	45

Maximum LINE D distance, Entrance panel - Door lock

Cable section mm ²	2 normal cables >0.2 mm ²	BTicino 336904 cable	Telephone twisted pair - 0.28 mm ²	A pair of the multi-pair data cable C9881U/5E
S+S- clamps	30 m	30 m	50 m	100 m

Note (1): LINE C valid for SFERA (342170 + 342510 + 342240), SFERA (342170 + 342550 + 342240), SFERA A/V (342560 + 342240) or LINEA 2000 entrance panels.

MAXIMUM DISTANCES AND CABLE FEATURES FOR CONNECTION OF THE ADDITIONAL POWER SUPPLY

Maximum LINE distance between the power supply and the entrance panel

Cable section mm ²	2 normal cables >0.2 mm ²	BTicino 336904 cable	Telephone twisted pair - 0.28 mm ²	A pair of the multi-pair data cable C9881U/5E
	50	100	75	50

WARNING: For situations or installation conditions other than the ones listed in this document (e.g. different entrance panels), the distances may be calculated using the **YouDiagram** software (this can be downloaded free of charge from the www.international.bticino.com website - ASSISTANCE AND TOOLS - TECHNICAL SOFTWARE.

