

Het fabrieksschema, dat u zoekt, staat op de volgende pagina.

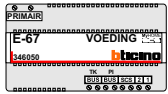

Groothandel Nelec heeft voor alle tweedraads deurcommunicatie van BTicino zeer duidelijke Nederlandse schema's en gebruiksaanwijzingen gemaakt. U vindt alles op www.nelec.com. Als u BTicino deurcommunicatie koopt bij Nelec, krijgt u voor ieder project een aansluitschema op maat, worden de buitenposten in elkaar gezet en zijn alle videofoons voorgeprogrammeerd. De monteur kan direct aan de slag en als hij een vraag heeft, krijgt hij bij Nelec iemand met verstand van zaken aan de lijn. Alle informatie staat duidelijk op www.nelec.com.

Klik op deze pagina voor meer informatie over dit product.

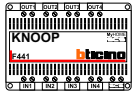
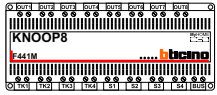
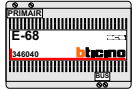

nelec
INTERCOM MADE EASY



The Bticino factory file you're looking for is on the next page.

Specialized wholesaler Nelec has made excellent manuals in Dutch for all BTicino two-wire intercom components. Get more information on this product by clicking this page.

wholesaler Nelec BV
intercom made easy
www.nelec.com
Gyroscoopweg 106
1042 AX Amsterdam
Postbus 20674
1001 NR Amsterdam

e-mail info@nelec.com

Telefoon 020-6 352 350
Verkoop 020-6 352 351
Administratie 020-6 352 352
Techniek 020-6 352 353
Offertes 020-6 352 357

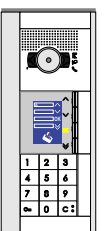
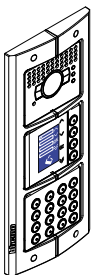
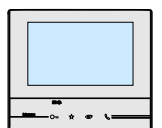
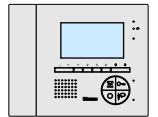
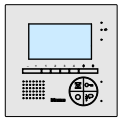



System expansion interface

346851

Description

Interface in DIN modular enclosure, used to increase the performance of the 2 WIRE system in one-family or apartment installations. It enables creating 2 WIRE risers with entrance panels at the bottom of the stairs, independent audio and video, as well as providing expansion for: regeneration of the video signal and extension of distances for a further 200 meters (cable item 336904 required), increase of the number of devices that can be connected to the BUS, and use of up to a maximum of 3 interface modules connected in cascade.

Technical data

Power supply from SCS BUS:	18 – 27 Vdc
Dissipated power:	2.25 W (max)
Operating temperature:	5 – 40°C
Absorption:	
IN clamp (configuration MOD = 0)	
Stand by absorption:	30 mA
Max. operating absorption:	30 mA
IN clamp (configuration MOD = 2 - MOD = 7)	
Stand by absorption:	20 mA
Max. operating absorption:	30 mA
IN clamp (configuration MOD = 5 - MOD = 6)	
Stand by absorption:	5 mA
Max. operating absorption:	30 mA
OUT clamp (configuration MOD = 0)	
Stand by absorption:	50 mA
Max. operating absorption:	50 mA
OUT clamp (configuration MOD = 2 - MOD = 7)	
Stand by absorption:	30 mA
Max. operating absorption:	50 mA
OUT clamp (configuration MOD = 5 - MOD = 6)	
Stand by absorption:	15 mA
Max. operating absorption:	50 mA

Dimensional data

Size: 4 DIN modules

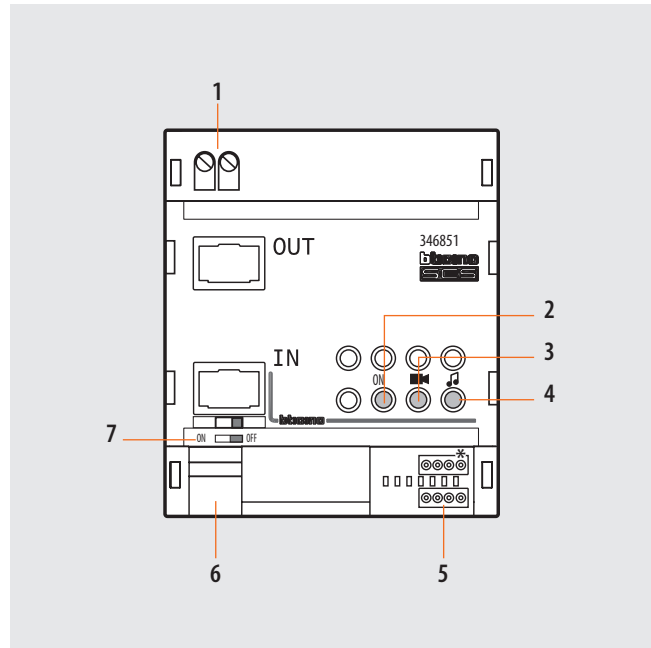

Legend

1. OUT clamps for the connection of the output SCS BUS
2. Interface status notification LED:
 - green flashing = STAND BY
 - green steady = IN - OUT connection active
3. Video signal level notification LED:
 - green steady = operation OK
 - green / red = operation nearing the limit
 - red steady = no video signal or limit exceeded
4. Presetting - NOT USED
5. Configurator socket - the socket marked with the asterisk * is NOT USED
6. SCS/BUS IN connection clamps
7. Line termination ON/OFF micro-switch

Configuration

The device **MUST BE** configured with physical configurator connection to the appropriate sockets as follows:

M = progressive number within the system

The configurator connected to the M sockets (from 1 to 99) assigns an identification number within the system to the interface. Addresses in M with (MOD = 0 - MOD = 2 - MOD = 7) and (MOD = 5 - MOD = 6) ARE NOT IN CONFLICT.

MOD = operating mode

The configurator connected to the MOD socket of the interface defines its operating mode as follows:

MOD = 0 (no configurator connected) - GALVANIC SEPARATION MODE

MOD = 2 - ENTRANCE PANEL LINE EXPANSION MODE

MOD = 0 (galvanic separation)

This configuration mode is used to double the line length or to increase the system performance - see the following example:

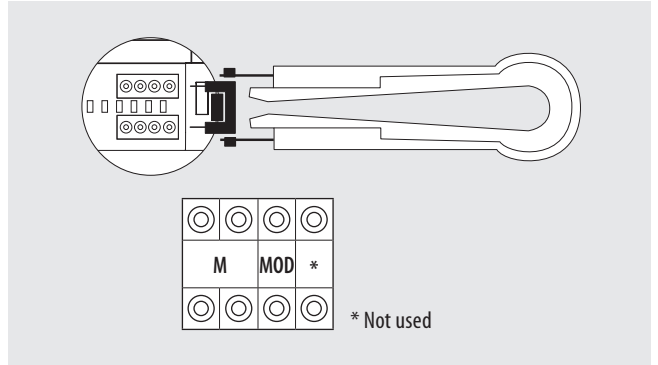

MOD = 5 - Independent risers MODE

MOD = 6 - Extended riser MODE

MOD = 7 - Extended riser expansion MODE

MOD = 2 (entrance panel line expansion)

This mode is used in systems with interface connection between the entrance panel and the F441 audio/video node, to extend the entrance panel line – see the following example:

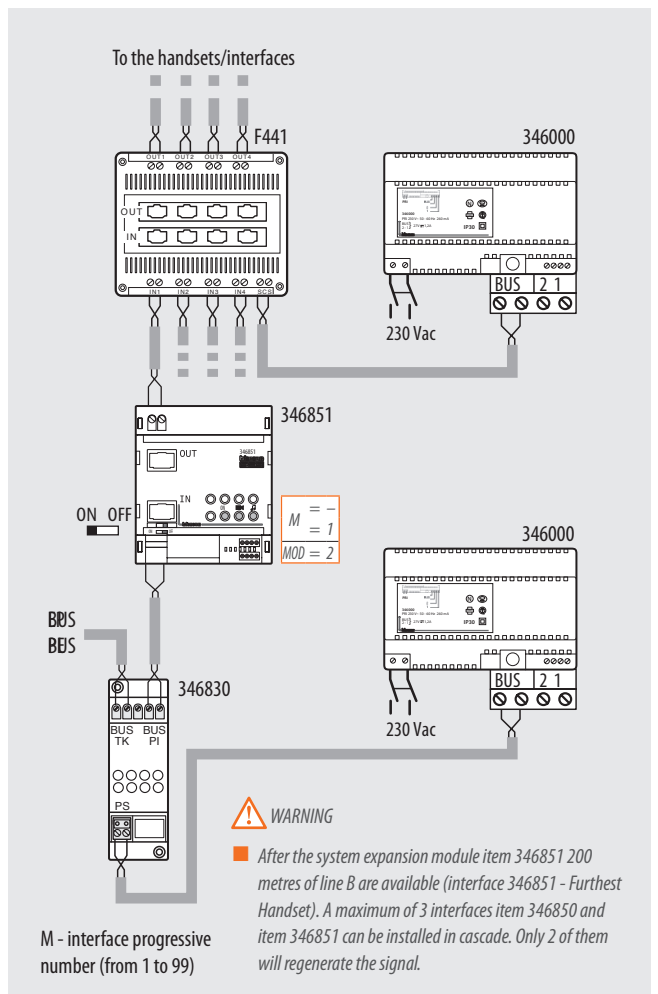
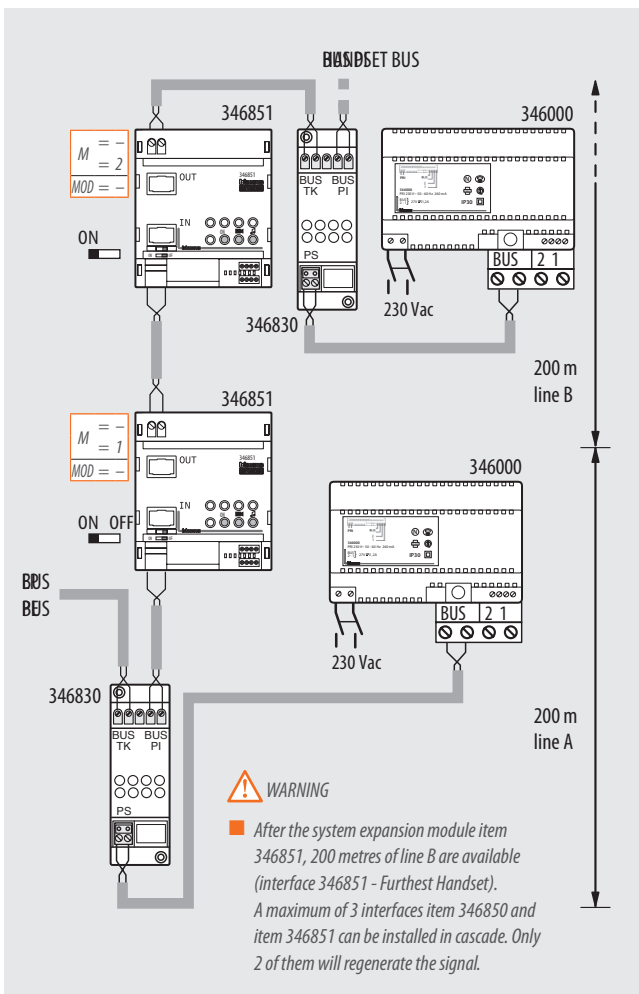

MOD = 5 (independent risers)

This mode is used to create systems with 2 WIRE risers, with independent audio and video (39 risers maximum) - see the following example:

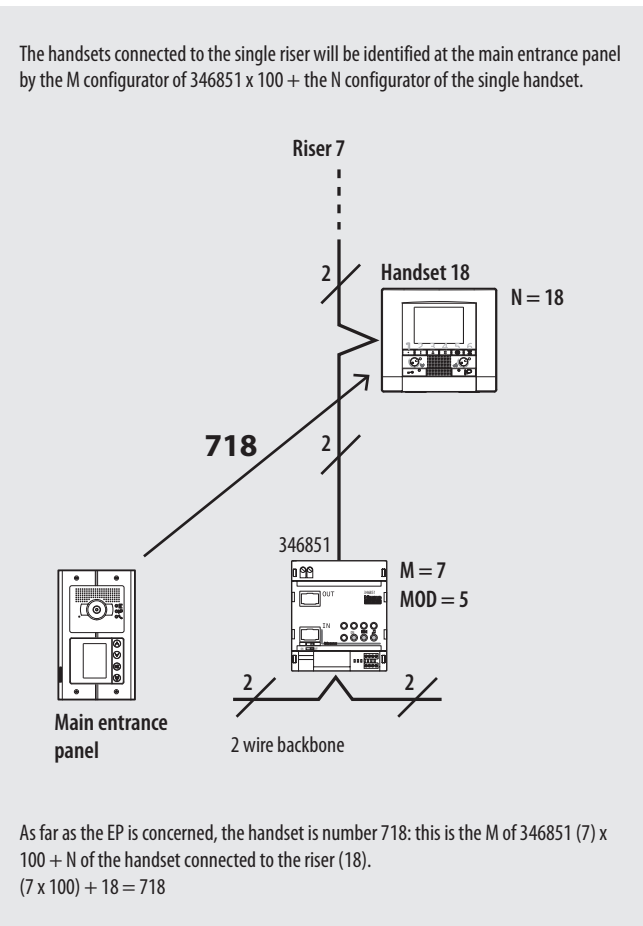
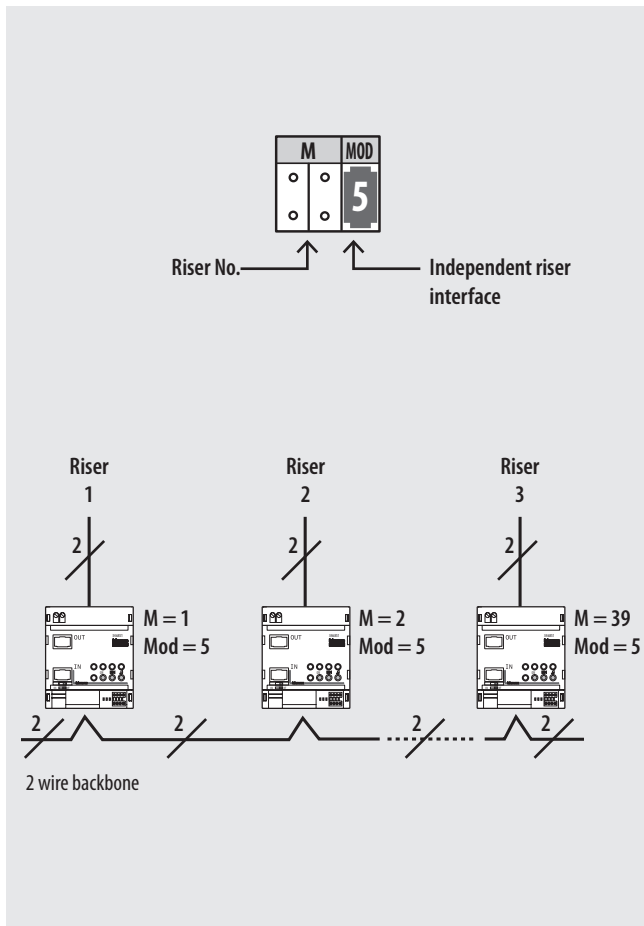

The handsets connected to the single riser will be identified at the main entrance panel by the M configurator of 346851 x 100 + the N configurator of the single handset.

As far as the EP is concerned, the handset is number 718: this is the M of 346851 (7) x 100 + N of the handset connected to the riser (18).
 $(7 \times 100) + 18 = 718$

NOTE:

A maximum of 3 interfaces item 346850 and 346851 can be installed in cascade. Only 2 of them will regenerate the signal.

MOD = 6 (extended riser)

MOD = 7 (extended riser expansion)

These configuration modes offer the possibility of riser line expansion up to the logic limit of 300 riser handsets (3 lines of 100 handsets each).

The limit of 100 handsets for each line is subjected to the use of apartment interface item 346850.

When interface item 346850 is not used, this 100 handsets line limit will be further reduced (refer to the system technical guide for more information).

Interface item 346850 CANNOT be installed on the last line. It is possible to cross up to 3 interfaces item 346850 and 346851 connected in cascade.

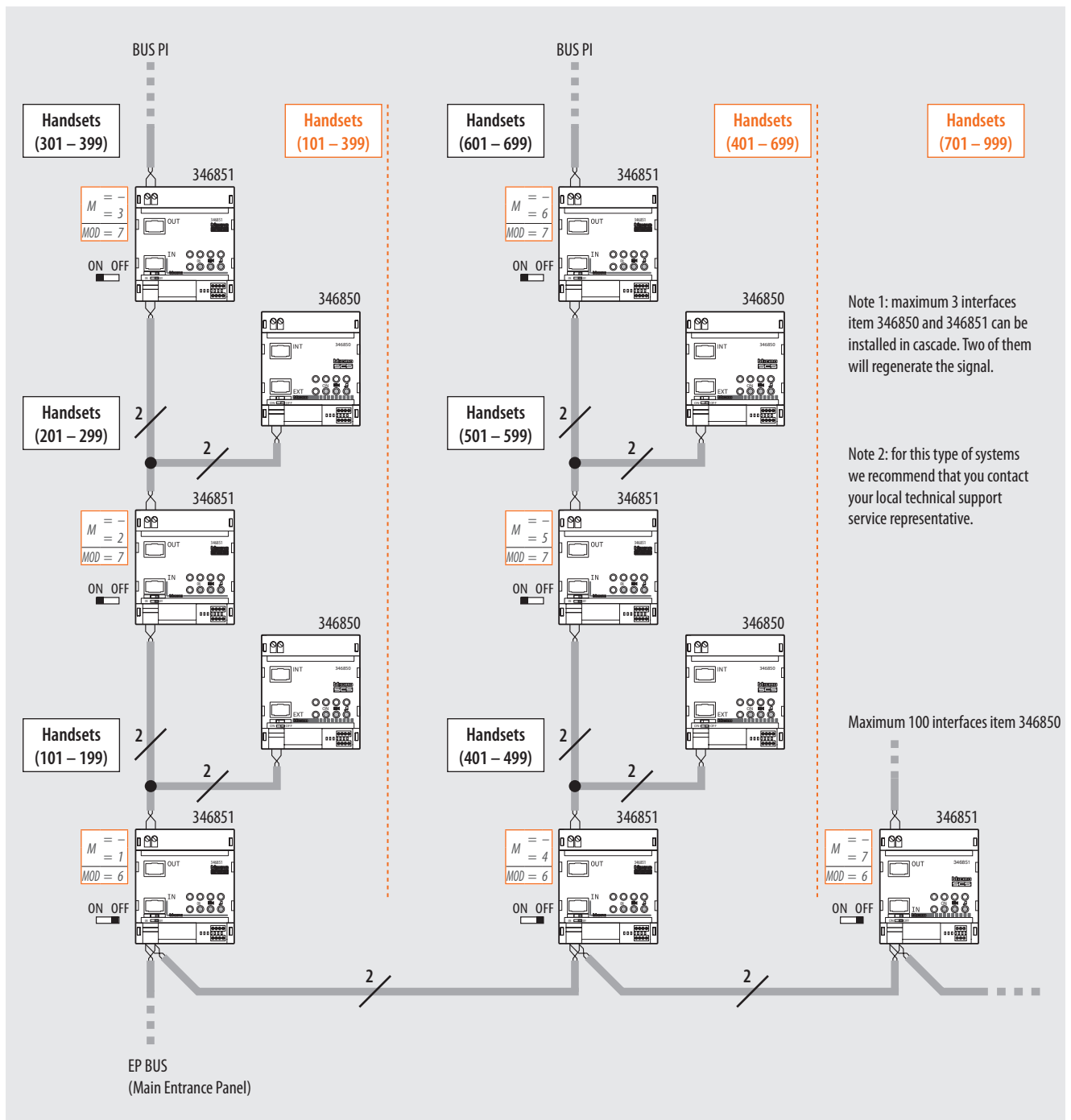

BT0063-a-FN